

Instruções de Montagem

Instrucciones de Montage

Assembly Instructions

REF.

BF-1015

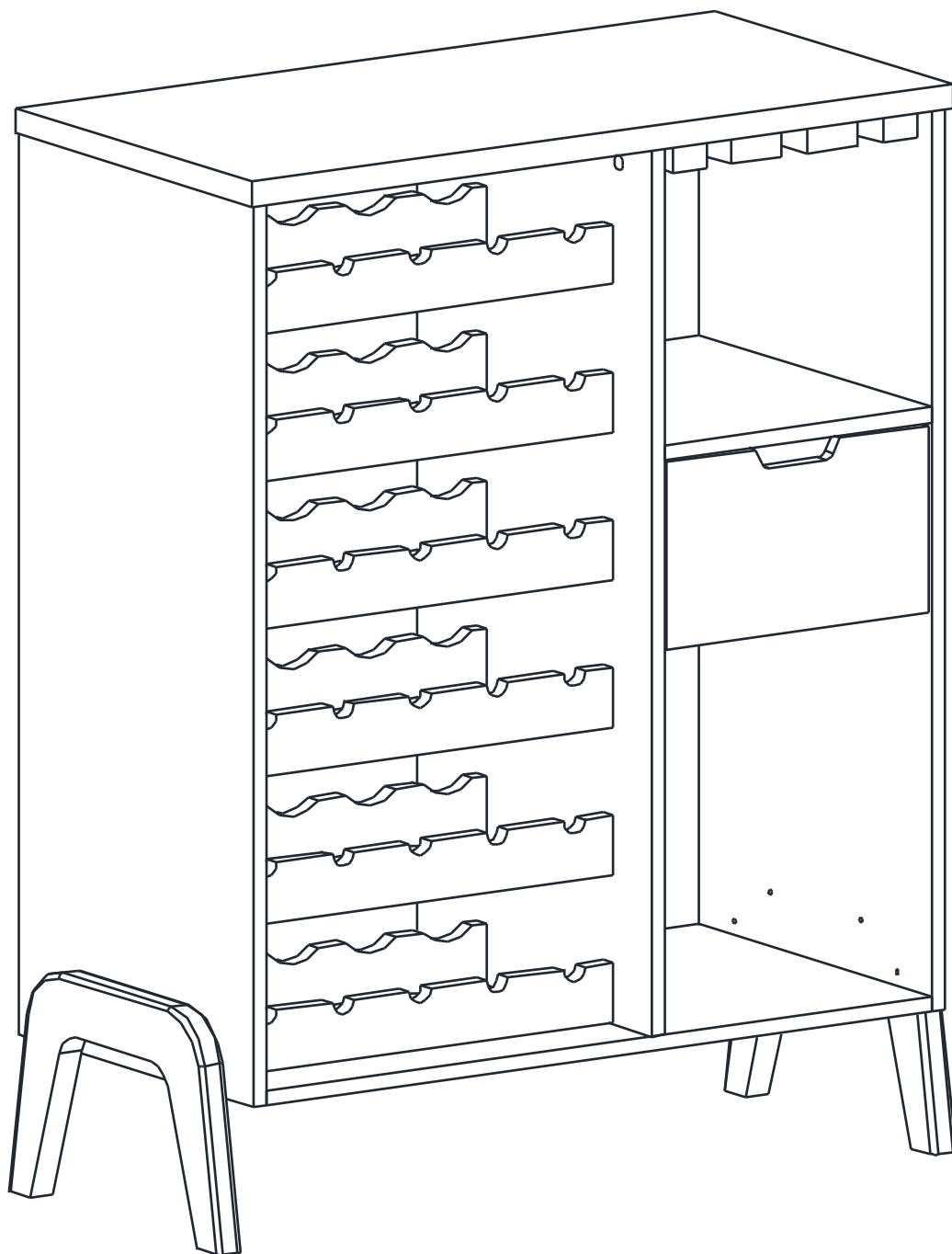

HECOL

móveis

Rua Arlindo Baccin, 601 - Lot. Vinhedos,
Bento Gonçalves, RS - CEP: 95707-150

Fone: (54) 3454-5900

contato@hecolmoveis.com.br







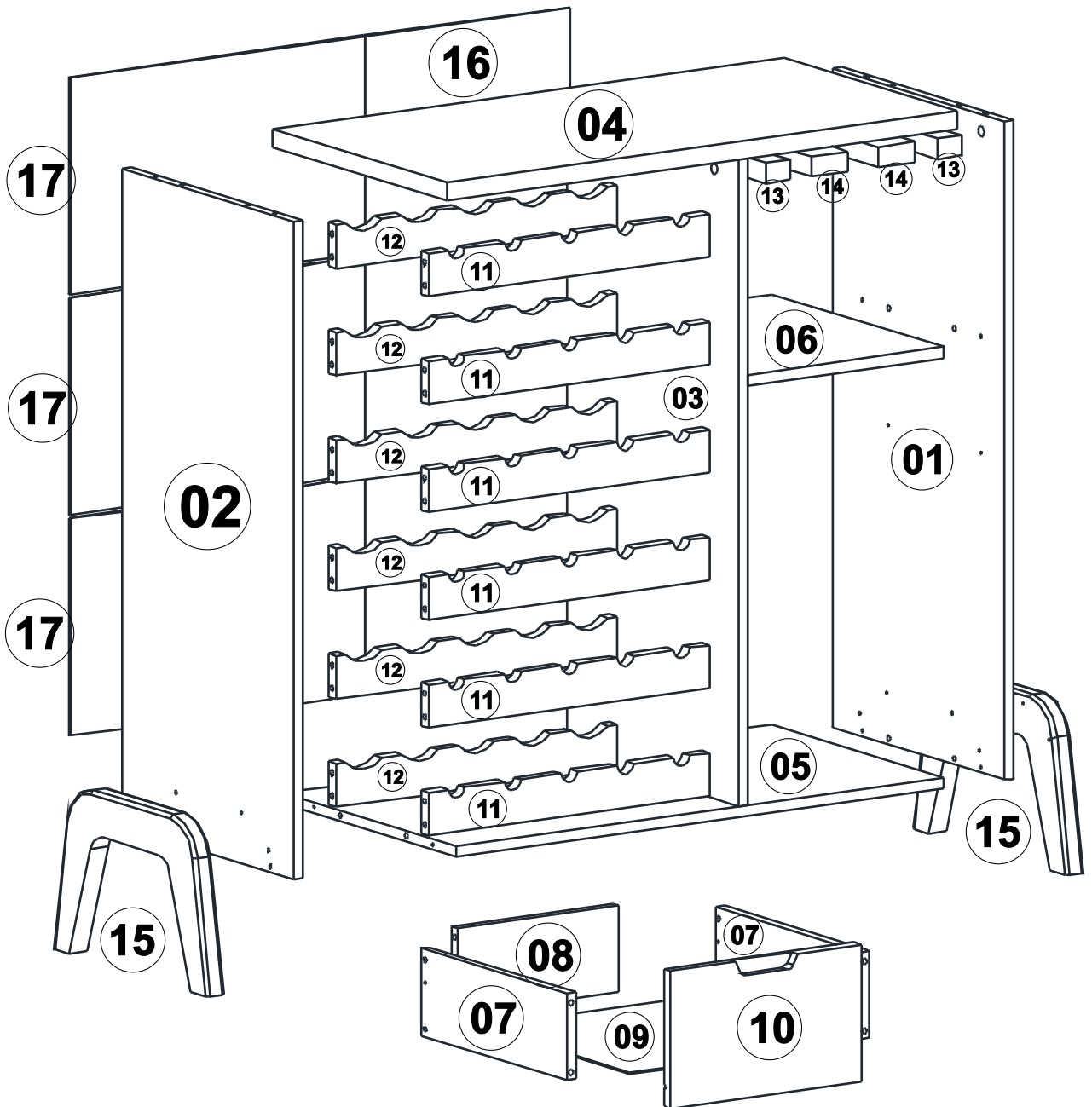

LISTA DE PEÇAS

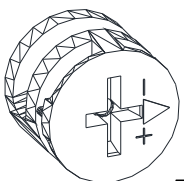
Nº PEÇA	CÓD. IND.	DESCRIÇÃO	QTD.	COMP. (mm)	LARG. (mm)	ESP. (mm)
01		Lateral Direita	1	910	415	15
02		Lateral Esquerda	1	910	415	15
03		Divisão	1	895	415	15
04		Tampo	1	835	420	25
05		Base Maior	1	795	415	15
06		Base Menor	1	320	415	15
07		Lateral de Gaveta	2	350	120	15
08		Costa de Gaveta	1	264	120	15
09		Fundo de Gaveta	1	294	355	3
10		Frente de Gaveta	1	312	189	18
11		Suporte Garrafa Frontal	6	460	60	18
12		Suporte Garrafa Traseira	6	460	60	18
13		Suporte Taça ``L``	2	390	40	18
14		Suporte Taça ``T``	2	390	60	18
15		Pé Goleira	2			28
16		Costa Maior	1	910	334	3
17		Costa Menor	3	480	300	3

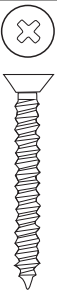
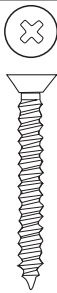
LISTA DE PEÇAS

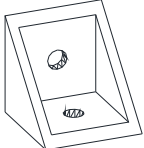
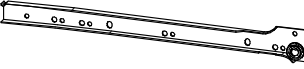

LISTA DE FERRAGENS

<p>A</p>  <p>x10</p> <p>Tambor Minifix 15x12mm</p>	<p>B</p>  <p>x10</p> <p>Parafuso Minifix</p>	<p>C</p>  <p>x08</p> <p>Parafuso 4,5x50mm CC</p>	<p>D</p>  <p>x16</p> <p>Parafuso 4,5x40mm CC</p>
<p>E</p>  <p>x08</p> <p>Parafuso 3,5x12mm CC</p>	<p>F</p>  <p>x08</p> <p>Parafuso 3,5x12mm CP</p>	<p>G</p>  <p>x72</p> <p>Cavilha 8x30mm</p>	<p>H</p>  <p>x40</p> <p>Prego 10x10</p>
<p>I</p>  <p>x04</p> <p>Chapa "L" 20x20x20mm</p>	<p>J</p>  <p>x01</p> <p>Corrediça 350mm</p>	<p>K</p>  <p>x02</p> <p>Perfil "H" 480mm</p>	

01

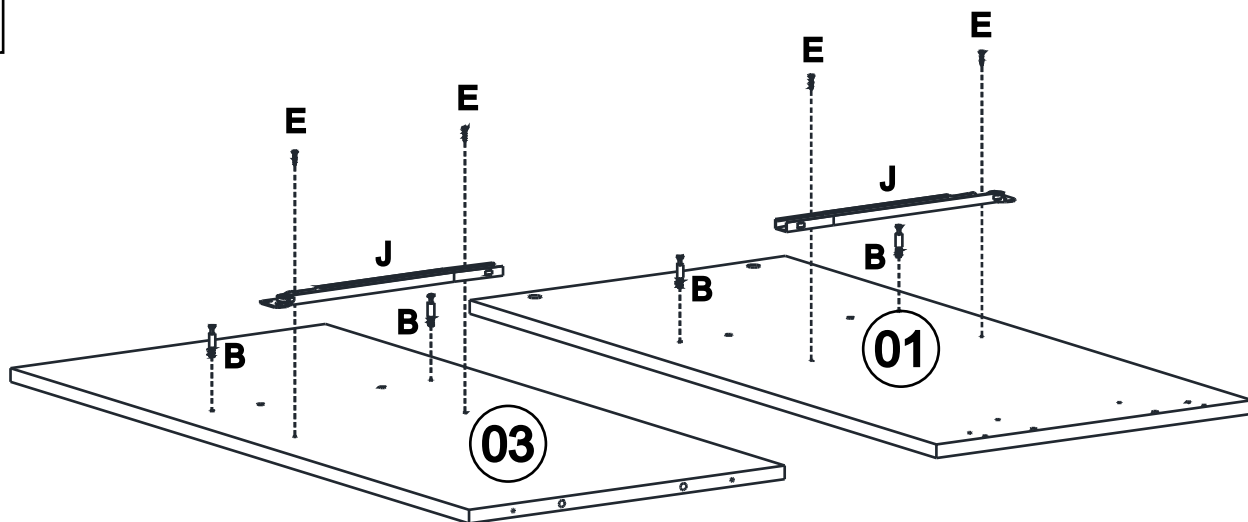

02

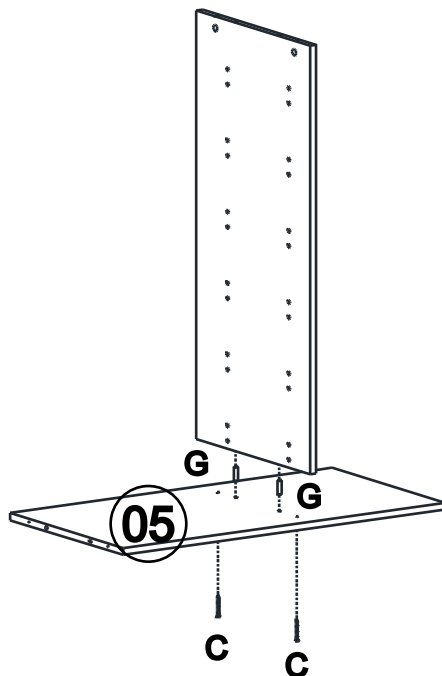

03

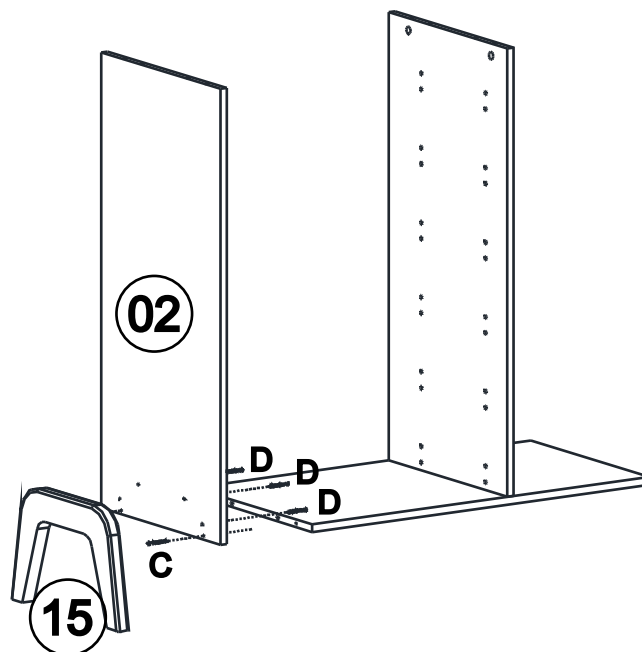

04

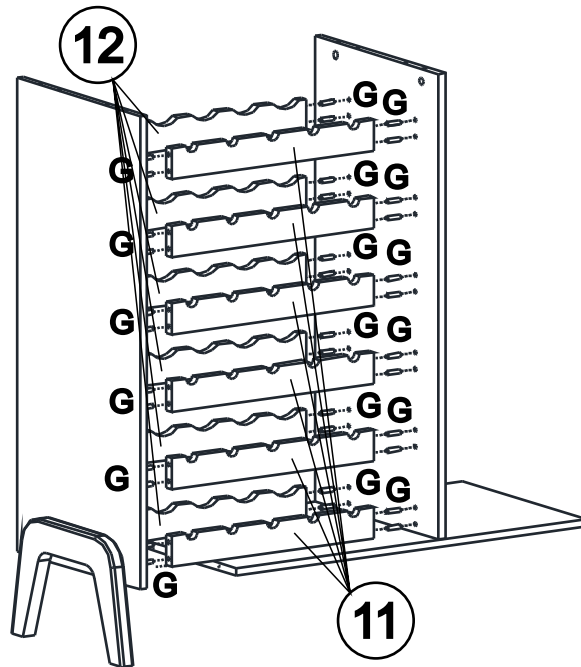

05

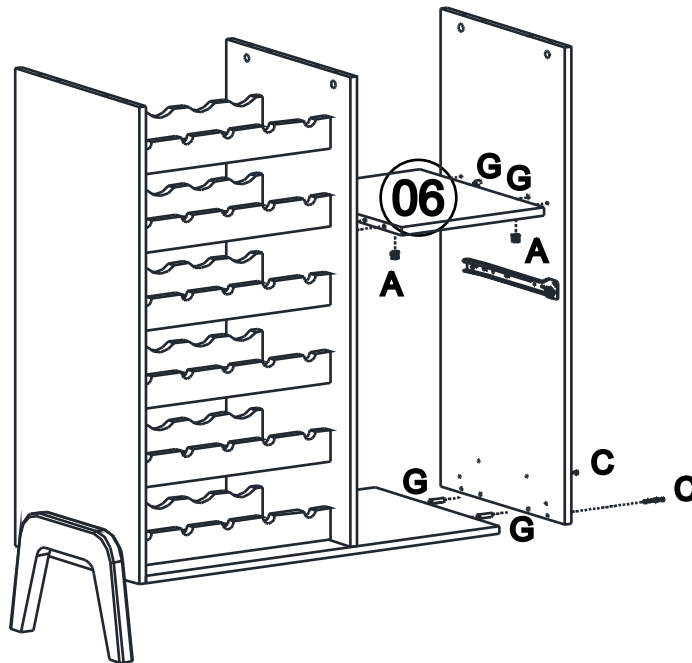

06

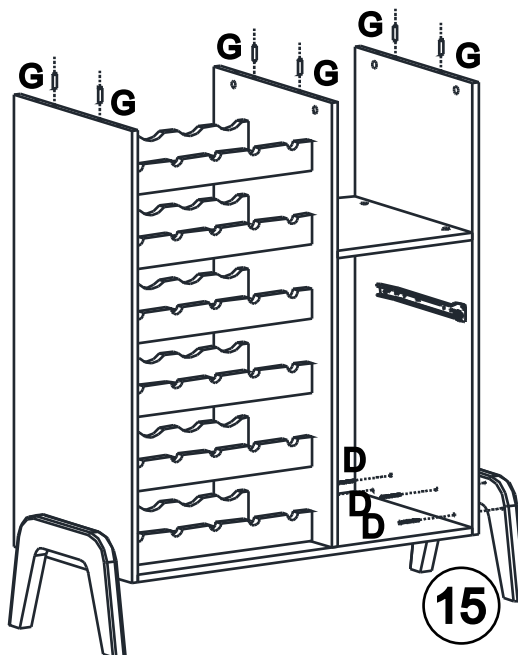

07

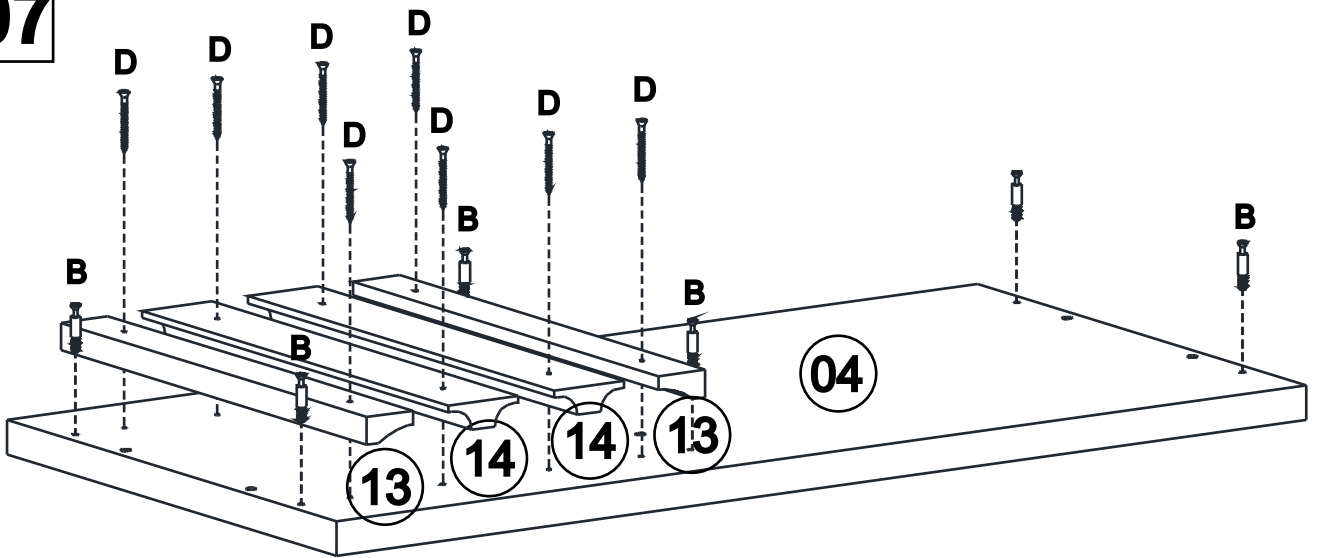

08

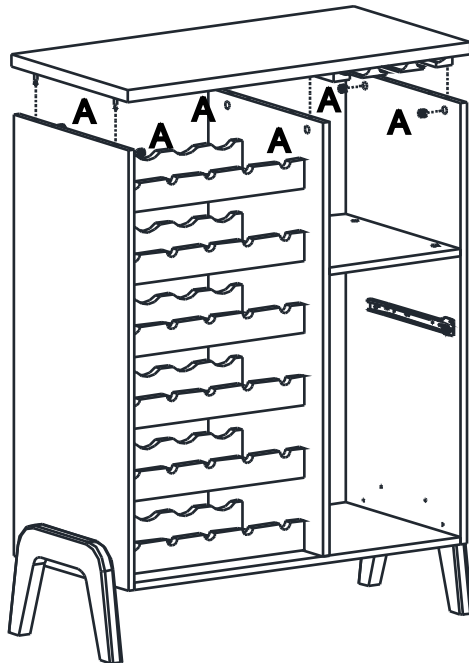

09

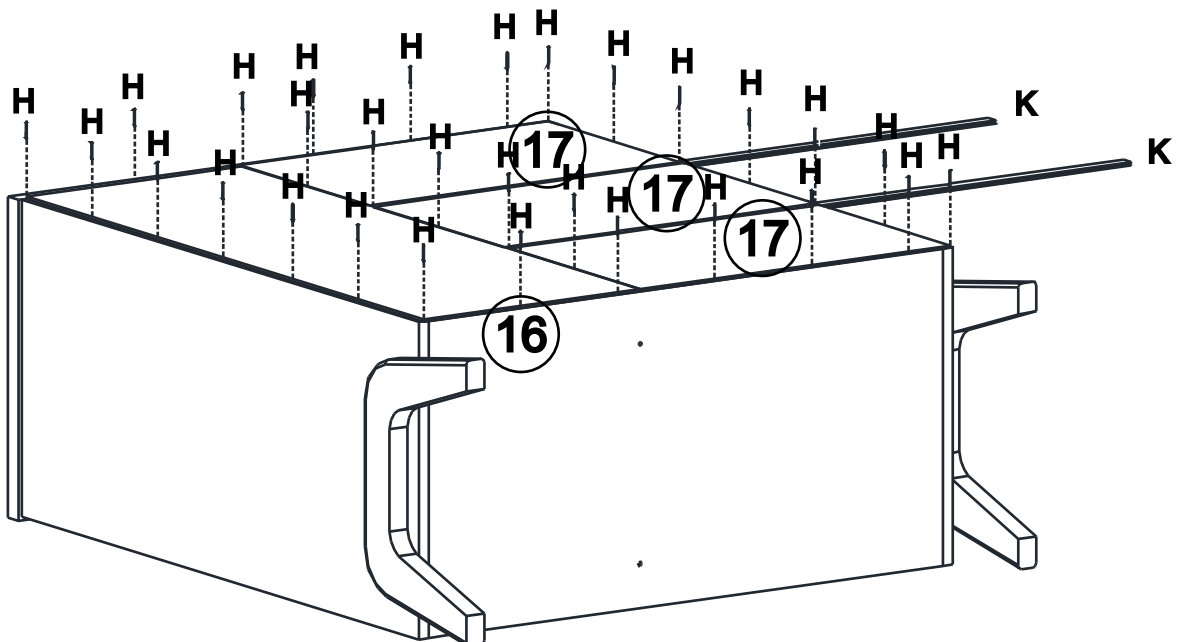

10

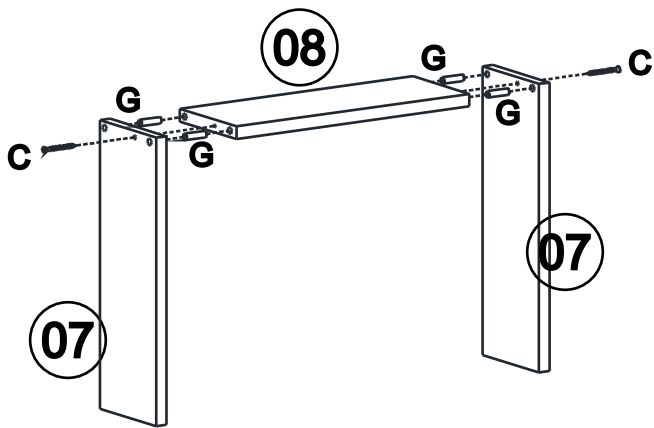

11

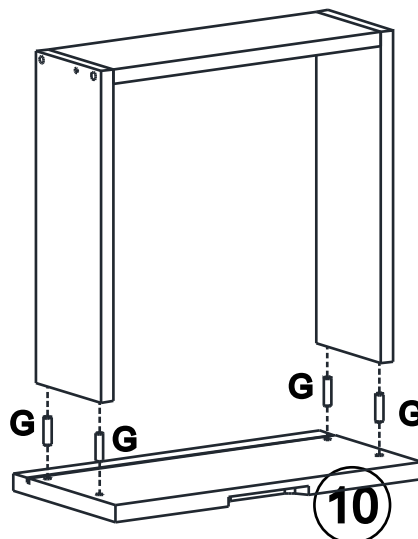

12

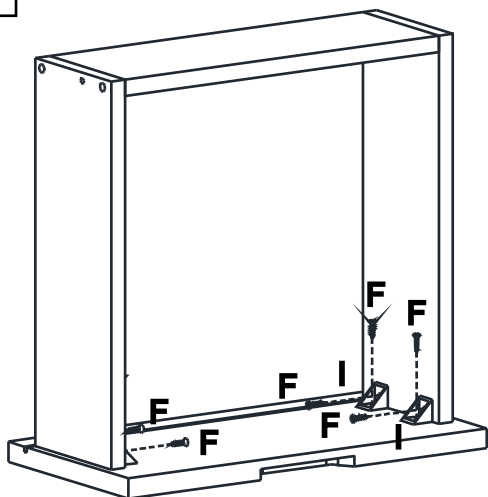

13

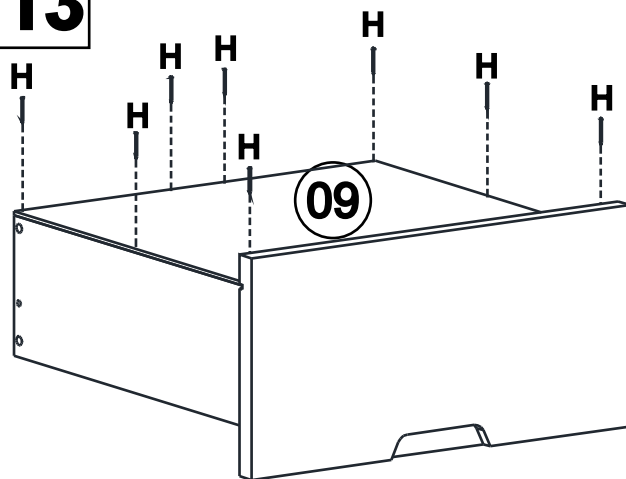

14

