

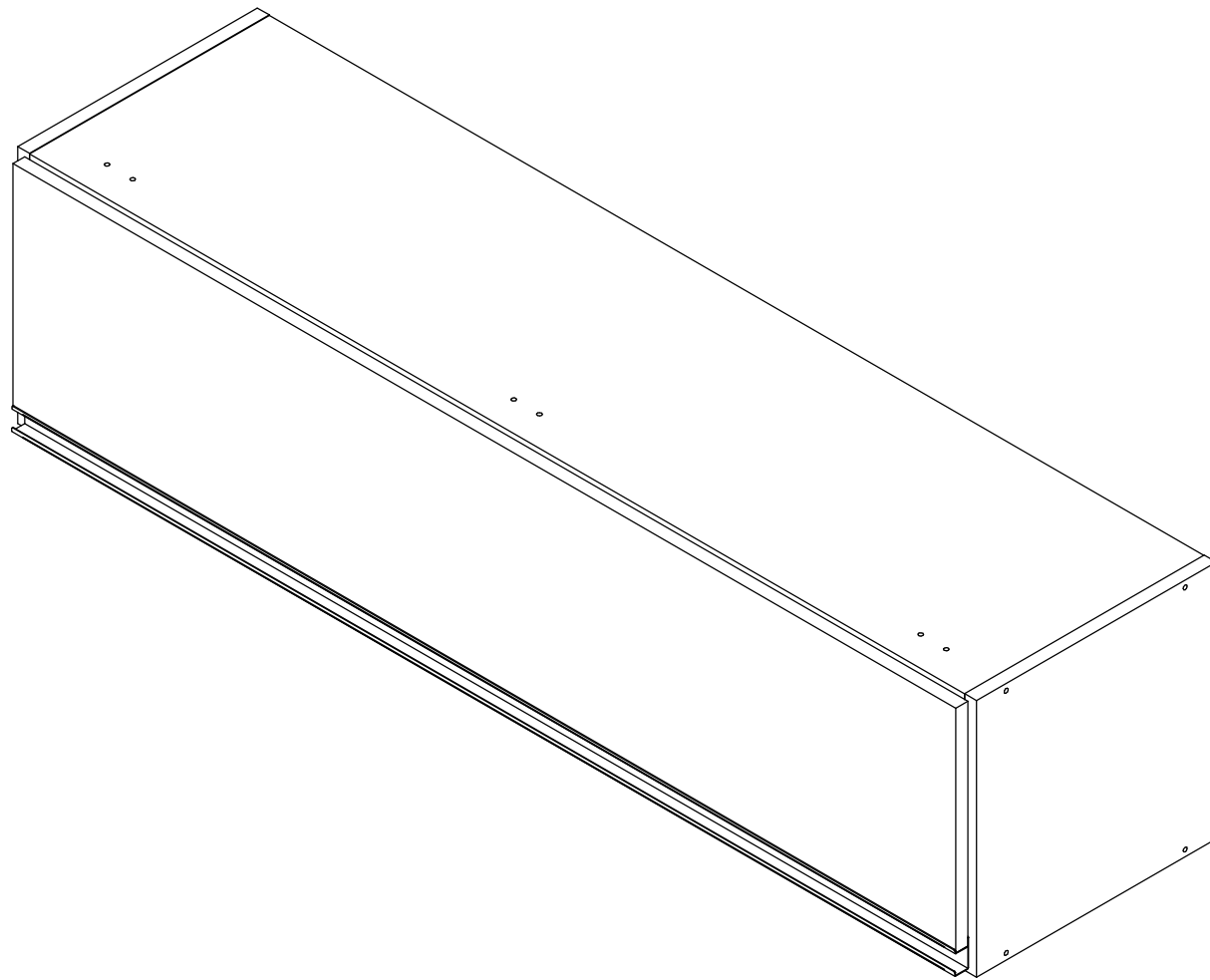









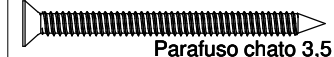

# Aéreo 120 0461

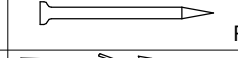
## Instruções de Montagem Assembly Instructions / Instrucciones de Montaje

01

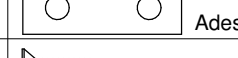

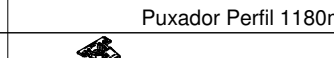
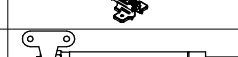
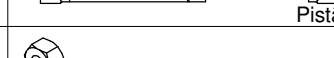
### Lista de ferragens Hardware list

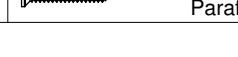
REF	Lista de materiais	QNT
A	 Cavilha 6 x 30	04
B	 Parafuso chato 3,5 x 40	08
C	 Parafuso flange 5 x 50	02
D	 Parafuso chato 4x25	03
E	 Prego 10 x 10	40
F	 Buchta Plastica 08mm	02
G	 Suporte Fixação Aéreo	02
H	 Proteção P/ Cantoneira	02
I	 Adesivo Tapa Furo	10
J	 Parafuso chato 3,5x14	17
K	 Puxador Perfil 1180mm	01
L	 Dobradiça	03
M	 Pistão	01
N	 Porca Sextavada	06
O	 Parafuso Maquina	06

### Lista de peças / Parts lists / Lista de piezas

Nº	Descrição	Dimensão	Quant.
01	Lateral/Lado	300 x 300 x 15	02
02	Tampo Aéreo/Tapa	1170 x 300 x 15	01
03	Base Aéreo/Base	1170 x 300 x 15	01
04	Porta Basculante/Puerta Abatible	1180 x 265 x 15	01
05	Costa/Costa	1194 x 294 x 3	01

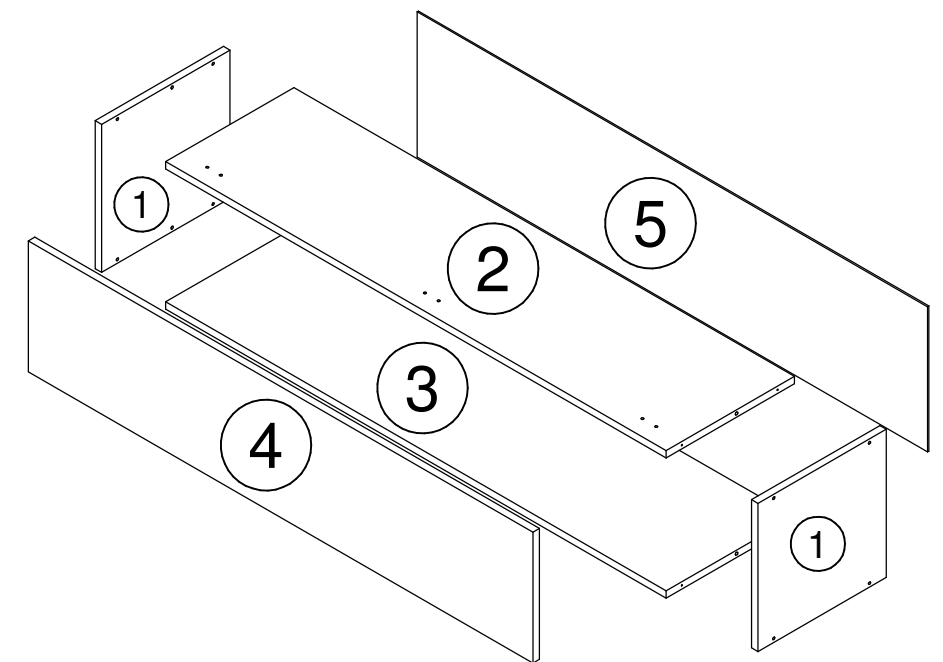

### Ferramentas Necessárias Herramientas Necesarias

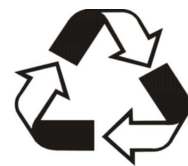
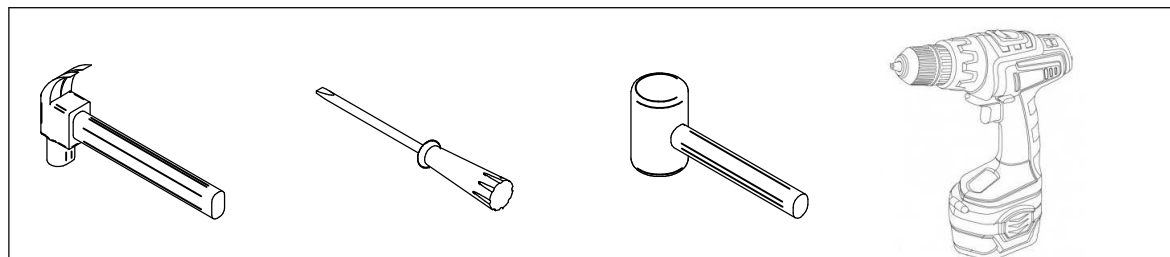

**Antes de montar seu móvel, leia cuidadosamente o Manual de Instruções e o mantenha para futuras consultas.  
OBRIGADO.**

**Antes de montar sus muebles, lea cuidadosamente el Manual de instrucciones y guárdelo para futuras referencias.  
GRACIAS**

Rev.: 00 - 21/05/2019

01

2x

1

2x

2

A

A

A

A

Obs: Fixar suporte de pistão em apenas uma das laterais '1'

K

K

M

02

J

J

K

4

J

L

J

J

M

L

03

1

2

3

1

B

B

B

B

04

5

E

E

E

05

4

L

J

J

Obs: Utilizar parafusos 'O' 'N' para a fixação da porta na peça N° 02.

06

Fixação do Pistão

M

07

### Fixação na Parede

C

F

G

H

Obs: Utilizar parafusos 'D' para união dos módulos.